

Pressure gauge

Part no.	Application	Dimension
KUX0000020	Miniature FRL series	1/8", φ 42mm
KUX0000030	U series, NU series	1/4", φ 53mm
KUX0000046	USFR Stainless steel FRL series	2"x20kgx1/4" SUS316
KUX0000053	USFR Stainless steel FRL series	2"x30kgx1/4" SUS316
KUX0000050	SSFR Miniature stainless steel FRL series	1/8", φ 42mm SUS316
KUX0001010	Miniature C series, NUFRL series	1", 0~10bar, 27mm
KUX0002010	URPL2 Precision Regulator	1.5", 0~0.2Mpa, 1/8" PT
KUX0002011	URPL4 Precision Regulator	1.5", 0~0.4Mpa, 1/8" PT
KUX0002012	URP Precision Regulator	1.5", 0~1Mpa, 1/8" PT



Semi-auto/Manual drain

Part no.	Type	Port size
ZGUX	Manual	6mm (PU tube)
ZGUX-S	Manual	
ZGUX-1	Semi-auto	
ZGUX-2	Semi-auto	
ZGUX-3	Semi-auto	

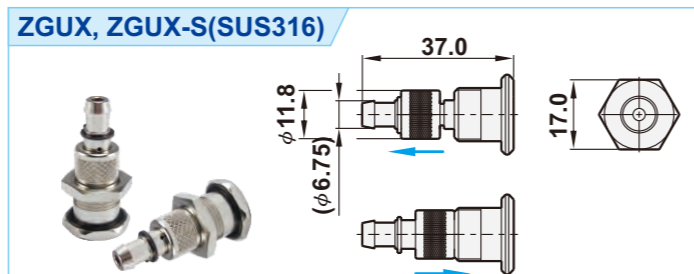

ZGUX-1, ZGUX-3(SUS316)

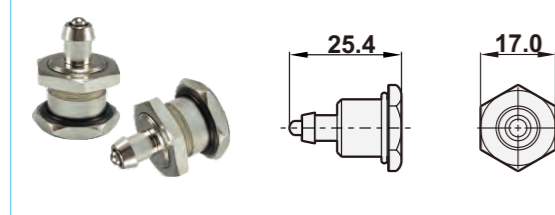

ZGUX-2

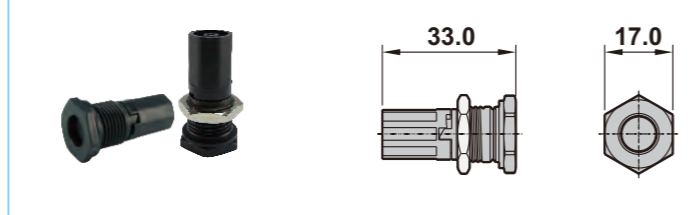

Sleeve valve

How to order

HV	-	02	N
Sleeve valve	Port size	Thread	
	01: 1/8"	Blank: G	
	02: 1/4"	N : NPT	
	03: 3/8"	R : PT	
	04: 1/2"		

HV-01, 02, 03, 04

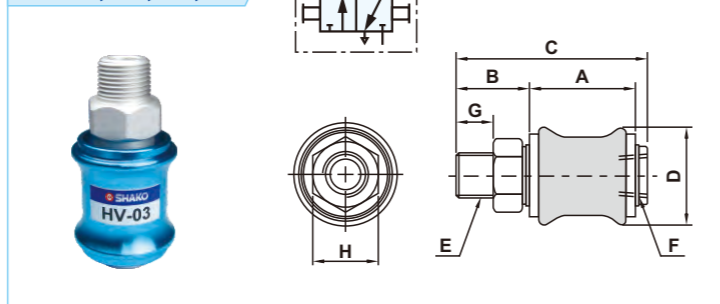

*Apply to standard FRL series 1/8", 1/4", 3/8", 1/2"

Part no.	Dimension	A	B	C	D	E	F	G	H
HV-01		30.0	17.0	50.0	φ 24.5	PT1/8"	PT1/8"	8.0	14.0
HV-02		32.5	22.0	58.0	φ 29.5	PT1/4"	PT1/4"	11.0	19.0
HV-03		39.0	26.0	68.5	φ 34.5	PT3/4"	PT3/4"	13.5	22.0
HV-04		50.0	32.0	85.5	φ 44.5	PT1/2"	PT1/2"	16.5	30.0

Filter bowl

Part no.	Application	Content
ZGUF-02B	U series (1/4", 3/8", 1/2")	Bowl with O-ring
ZGUF-06B	U series (3/4", 1")	
ZGUF-02BA (Anti-acid & Alkali bowl)	U series (1/4", 3/8", 1/2")	
ZGUF-02BAL (Aluminum bowl)	U series (1/4", 3/8", 1/2")	
ZGF200BA (Anti-acid & Alkali bowl)	Miniature A series	
ZGF200BB	Miniature C series	
ZGF200B	Miniature A series	
ZGUSF-04B	USFR Stainless steel FRL series	
ZGUSF-02B	SSFR Miniature stainless steel FRL series	



Lubricator bowl

Part no.	Application	Content
ZGUL-02B	U series (1/4", 3/8", 1/2")	Bowl with O-ring
ZGUL-06B	U series (3/4", 1")	
ZGUL-02BA (Anti-acid & Alkali bowl)	U series (1/4", 3/8", 1/2")	
ZGUL-02BAL (Aluminum bowl)	U series 1/4", 3/8", 1/2")	
ZGL200BA (Anti-acid & Alkali bowl)	Miniature A series	
ZGL200BB	Miniature C series	
ZGL200B	Miniature A series	



Filter element (PE)

Part no.	Application	Content
KUS0032041 (40μm)	Miniature A series	
KUS0032042 (5μm)	Miniature A series	
KUN0010035 (40μm)	U series (1/4", 3/8", 1/2") - NU series	φ 28
KUN0010036 (5μm)	U series (1/4", 3/8", 1/2") - NU series	φ 28
KUB0008060 (40μm)	U series (3/4", 1")	
KUB0008061 (5μm)	U series (3/4", 1")	



Sintered brass

Part no.	Application	Content
NUS0032041 (40μm)	Miniature A series	
NUS0032042 (5μm)	Miniature A series	
NUN0010035 (40μm)	U series (1/4", 3/8", 1/2") - NU series	φ 28
NUN0010036 (5μm)	U series (1/4", 3/8", 1/2") - NU series	φ 28
NUB0008064 (40μm)	U series (3/4", 1")	
NUB0008063 (5μm)	U series (3/4", 1")	



Automatic drain

Features

1. Completely drain water together with polluted particles and oils at once without remnants on filter bowl.
2. Automatically remove remaining water on filter bowl after air pressure is shut off.
3. Working pressure: 0.5~9.9kgf/cm²
Proof pressure: 15kgf/cm²
Ambient temperature: -5~+60(No freezing)

Part no.	Thread	Color
D0014W	14mm (Male thread)	Black

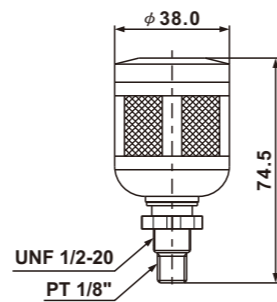

Features

1. Working pressure: 0.8 ~ 10 kgf/cm²
2. Leverage design and electrical power free, shorter and smaller than competitors' products.
3. Discharge capacity: 3~5cc/time.
*Suitable for: For Miniature A series

Part no.	Thread	Color
AD-01	M5xP0.8	Black+Orange

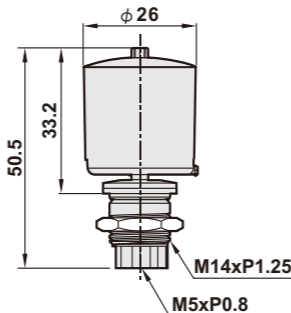

Connecting seat

Part no.	Application	Content
ZGFR-500A-03	FRL600A, FRL700A, FR500A, F200A	Seat with O-ring

**Remark: Auto Drain demand for Mini type Model A only.



Spacer block

Part no.	Application	Content
ZGUFR02SB	UFR/L-02, 03, 04	Block, O-ring, Screw, Washer, Plug
ZGUFR06SB	UFR/L-06, 08	Block, O-ring, Screw, Washer, Plug
ZGNUFR03SB	NUFRL-02, 03, 04	Spacer Block, O-ring, Screw, Plug
ZGNUFR03SB-1	NUFRL-02, 03, 04	Standard Block, O-ring, Screw



Closed block/Gauge block

Part no.	Application	Content
ZGNUFR03CB	NUFRL-02, 03, 04	Closed block, O-ring, Screw
ZGNUFR03CB-1		Gauge block, O-ring, Screw

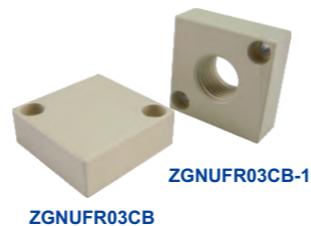

Mounting bracket

<p>ZGNUFR/L-03MAB NUFRL, NUFRL/L (1/4", 3/8", 1/2")</p>	<p>ZGNUFR/L-03MB NUFR, NUF, NUL (1/4", 3/8", 1/2")</p>	<p>ZGNUFR/L-03MAB-1 NUFR, NUFRL/L</p>	
<p>ZGURP-02MB URP series</p>	<p>ZGFR600CMB FRL600C, FRL700C</p>	<p>ZGFR500CMB FR500C, F200C, L200C</p>	<p>ZGR200MB R200, NR200</p>
<p>ZGUFR/L-06MB U series (3/4", 1/2")</p>	<p>ZGUFR/L-02MB U series (1/4", 3/8", 1/2")</p>	<p>ZGUSFRC-08MB Stainless steel FRL series (3/4", 1")</p>	
<p>ZGFR500AMB Miniature A series</p>	<p>ZGUSFR/L-04MSB Stainless steel FRL series (1/4", 3/8", 1/2")</p>	<p>ZGSSFR500MB, ZGFR500MB Miniature stainless steel FRL series</p>	